



UNIVERSAL BRUSHES FOR STENTERS

body dimensions				fill						Gutmann article-nr.
inner ø (di/d2)	outer ø (da)	width (b)	pitch circle Ø (TK)	fill material	trim mm	rows	operating width (B) mm	style		
mm	mm	mm	mm					straight	conv.	
										

Universal Brush Ø 201 mm (D)



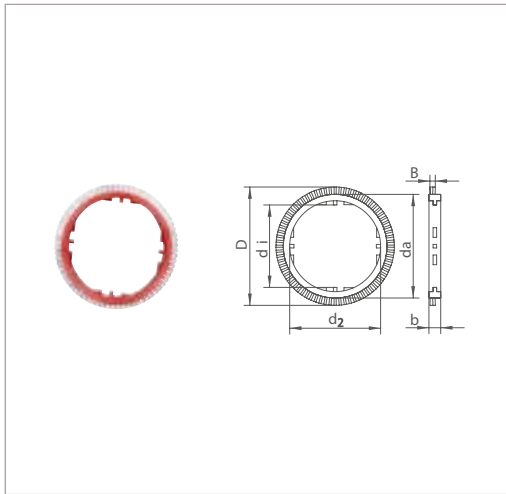

140/154	176.0	20.0		Calcutta bristle grey	12.5	4	17	•		8221-0201-04
140/154	176.0	20.0		Chungking bristle black	12.5	4	17	•		8221-0201-14
140/154	176.0	20.0		horsehair black	12.5	4	17	•		8221-0201-24
140/154	176.0	20.0		PA 6.6 white 0.40 mm	12.5	4	17	•		8221-0201-44
140/154	176.0	20.0		PA 6.6 white 0.70 mm	12.5	4	17	•		8221-0201-74
140/154	176.0	20.0		stainless steel wire 0.25 mm	12.5	4	17	•		8221-0201-84
140/154	176.0	20.0		Calcutta bristle grey	12.5	3	9		•	8221-1201-03
140/154	176.0	20.0		Chungking bristle black	12.5	3	11		•	8221-1201-13
140/154	176.0	20.0		horsehair black	12.5	3	10		•	8221-1201-23
140/154	176.0	20.0		PA 6.6 white 0.40 mm	12.5	3	9		•	8221-1201-43
140/154	176.0	20.0		PA 6.6 white 0.70 mm	12.5	3	8		•	8221-1201-73

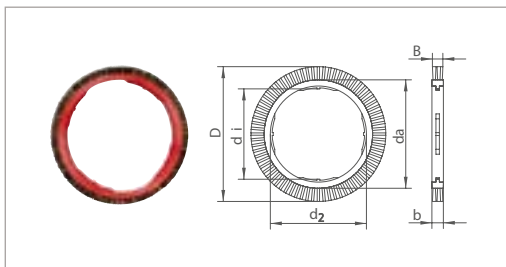
Universal Brush Ø 212 mm (D)



158/167	189.0	20.0		Calcutta bristle grey	11.5	4	11		•	8231-1212-04
---------	-------	------	--	-----------------------	------	---	----	--	---	--------------

UNIVERSAL BRUSHES FOR STENTERS

body dimensions				fill						Gutmann article-nr.
inner ø (di/d2)	outer ø (da)	width (b)	pitch circle Ø (TK)	fill material	trim	rows	operating width (B)	style		
mm	mm	mm	mm					mm	mm	
										

Universal Brush Ø 220 mm (D)

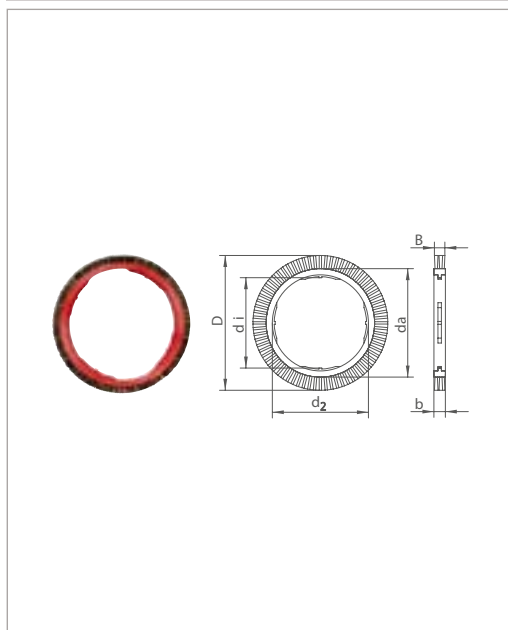

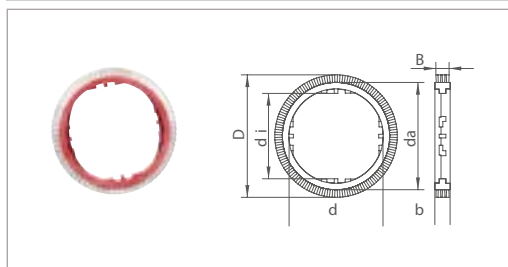

158/167	189.0	20.0		horsehair black	15.5	4	18	•		8231-0220-24
158/167	189.0	20.0		Chungking bristle black	15.5	4	18	•		8231-0220-34
158/167	189.0	20.0		PA 6.6 white 0.40 mm	15.5	4	17	•		8231-0220-44
158/167	189.0	20.0		Calcutta bristle grey	15.5	4	18	•		8231-0220-54
158/167	189.0	20.0		PP white 0.40 mm	15.5	4	17	•		8231-0220-64
158/167	189.0	20.0		PA 6.6 white 0.70 mm	15.5	4	18	•		8231-0220-74
158/167	189.0	20.0		stainless steel wire 0.25 mm	15.5	4	21	•		8231-0220-84
158/167	189.0	20.0		goat hair white	15.5	4	19	•		8231-0220-Z4
158/167	189.0	20.0		horsehair black	15.5	4	12		•	8231-1220-24
158/167	189.0	20.0		Chungking bristle black	15.5	4	10		•	8231-1220-34
158/167	189.0	20.0		PA 6.6 white 0.40 mm	15.5	4	10		•	8231-1220-44
158/167	189.0	20.0		Calcutta bristle grey	15.5	4	10		•	8231-1220-54
158/167	189.0	20.0		PA 6.6 white 0.70 mm	15.5	4	11		•	8231-1220-74
158/167	189.0	20.0		stainless steel wire 0.25 mm	15.5	4	11		•	8231-1220-84

Universal Brush Ø 201 mm (D)



140/154	176.0	25.0		Calcutta bristle grey	12.5	6	22	•		8311-0201-06
140/154	176.0	25.0		Chungking bristle black	12.5	6	21	•		8311-0201-16
140/154	176.0	25.0		PA 6.6 white 0.40 mm	12.5	6	23	•		8311-0201-46

UNIVERSAL BRUSHES FOR STENTERS

body dimensions				fill						Gutmann article-nr.
inner \varnothing (di/d2)	outer \varnothing (da)	width (b)	pitch circle \varnothing (TK)	fill material	trim mm	rows	operating width (B) mm	style		
mm	mm	mm	mm					straight 	conv. 	

Universal Brush \varnothing 206 mm (D)

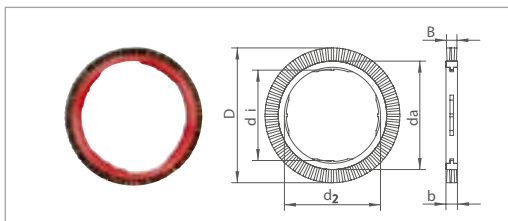

140/1565	174.0	25.0		PA 6.6 white 0.40 mm	16.0	3	14		•	8321-1206-43
140/1565	174.0	25.0		PA 6.12 black 0.50 mm	16.0	3	14		•	8321-1206-X3

Brush for cutting device \varnothing 85 mm (D) (also check bushings for 8411-....-..)

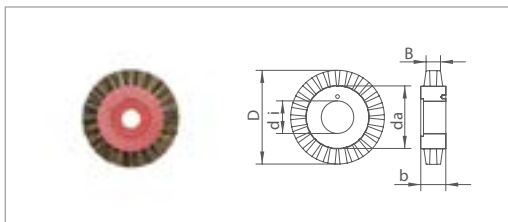

26	50.0	20.0		Calcutta bristle grey	17.5	4	18		•	8411-0085-54
----	------	------	--	-----------------------	------	---	----	--	---	---------------------

Postpinning Brush \varnothing 75 mm (D) (also check bushings for 8411-....-..)

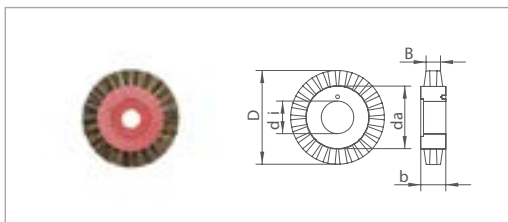

26	50.0	20.0		Calcutta bristle grey	12.5	3	10		•	8411-1075-03
26	50.0	20.0		Chungking bristle black	12.5	3	10		•	8411-1075-13

UNIVERSAL BRUSHES FOR STENTERS

body dimensions				fill						Gutmann article-nr.
inner \emptyset (di/d2)	outer \emptyset (da)	width (b)	pitch circle \emptyset (TK)	fill material	trim	rows	operating width (B) mm	style		
mm	mm	mm	mm					straight	conv.	
					mm					

Bushings for 8411-....-.. (50-8412 with key slot (for cutting device))

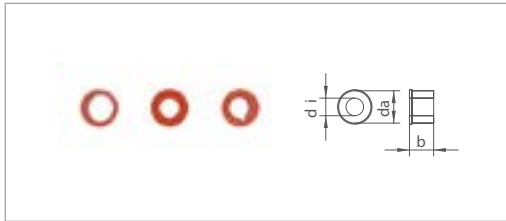

14	26	19.5								50-8411
15	26	19.5								50-8412

We offer the world's most extensive product portfolios of stenter brushes.
If, contrary to expectations, none of them fits your requirements,
please ask us to for an individual production of your stenter brush.